



SECURITY DIRECT
www.securitydirectuk.com

Power Manager
Battery Backup Unit



INTRODUCTION

The UPS described in this manual is a high quality product which has been carefully designed and built in order to guarantee the highest levels of performance.

This device can be installed by anyone on the condition that they have **READ THIS INSTALLTION AND USER MANUAL CAREFULLY.**

The UPS and the Battery Box generate DANGEROUS internal electrical voltages. All maintenance operations must be carried out by suitably qualified operators.

This manual contains detailed instructions for using and installing the UPS and any additional Battery boxes.

ENVIRONMENTAL PROTECTION

In the development of its products, the company devotes abundant resources to analysing the environmental aspects. All our products pursue the objectives defined in the environmental management system developed by the company in compliance with applicable standards.

No hazardous materials such as CFCs, HCFCs or asbestos are used in this product.

When evaluating packaging, the choice of material has been made favouring recyclable materials. For correct disposal, please separate and identify the type of material of which the packaging is made according to the table below. Dispose of all material in compliance with applicable standards in the country in which the product is used.

<i>DESCRIPTION</i>	<i>MATERIAL</i>
Box	Cardboard
Packaging corner	Stratocell
Protective bag	Polythene
Accessories bag	Polythene

DISPOSING OF THE PRODUCT

The UPS and the Battery Box contain electronic PCBs and batteries which are considered TOXIC and HAZARDOUS waste. When the product reaches the end of its operating life, dispose of it in accordance with applicable local legislation. Disposing of the product correctly contributes to respecting the environment and personal health.

© The reproduction of any part of this manual, in whole or in part, is forbidden without the prior consent of the manufacturer. In order to make improvements, the manufacturer reserves the right to modify the product described at any moment and without notice.

CONTENTS

PRESENTATION	4
<i>UPS VIEWS</i>	<i>5</i>
<i>FRONT VIEW</i>	<i>5</i>
<i>REAR VIEW</i>	<i>6</i>
<i>DISPLAY PANEL VIEW</i>	<i>7</i>
INSTALLATION	8
<i>INITIAL CONTENT CHECK</i>	<i>8</i>
<i>INSTALLATION ENVIRONMENT</i>	<i>8</i>
USE	9
<i>CONNECTIONS AND SWITCHING ON FOR THE FIRST TIME</i>	<i>9</i>
<i>SWITCHING ON FROM THE MAINS</i>	<i>9</i>
<i>SWITCHING ON FROM THE BATTERY</i>	<i>9</i>
<i>SWITCHING OFF THE UPS</i>	<i>9</i>
<i>DISPLAY PANEL MESSAGES</i>	<i>10</i>
<i>UPS STATUS MESSAGES</i>	<i>10</i>
<i>MEASUREMENT DISPLAY AREA</i>	<i>11</i>
<i>CONFIGURING THE OPERATING MODE</i>	<i>12</i>
<i>POSSIBLE SETTINGS</i>	<i>12</i>
<i>ADDITIONAL FUNCTIONS</i>	<i>12</i>
<i>SOFTWARE</i>	<i>13</i>
<i>MONITORING AND CONTROL SOFTWARE</i>	<i>13</i>
<i>CONFIGURATION SOFTWARE</i>	<i>13</i>
<i>UPS CONFIGURATION</i>	<i>14</i>
<i>COMMUNICATION PORTS</i>	<i>15</i>
<i>RS232 CONNECTOR</i>	<i>15</i>
<i>COMMUNICATION SLOT</i>	<i>15</i>
<i>BATTERY PACK REPLACEMENT</i>	<i>16</i>
TROUBLESHOOTING	18
<i>ALARM CODES</i>	<i>20</i>
<i>FAULT</i>	<i>20</i>
<i>LOCK</i>	<i>21</i>
TECHNICAL DATA	22

PRESENTATION

The **VISION** series is the ideal solution for high end users who require high security and versatility from their power systems. The VISION is the best protection system available for network devices, servers and conventional storage systems.

The **VISION** series is a range of UPS which utilises the very latest Line Interactive technology and sinusoidal output voltage waveforms. This technology allows high efficiency and reduced energy consumption, whilst guaranteeing a high level of protection against disturbances from the mains supply.

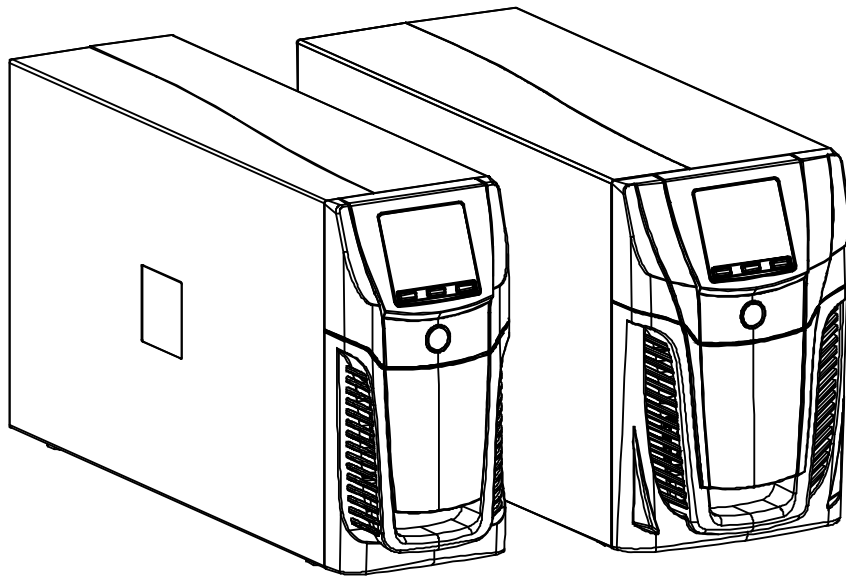

UPS VIEWS

FRONT VIEW

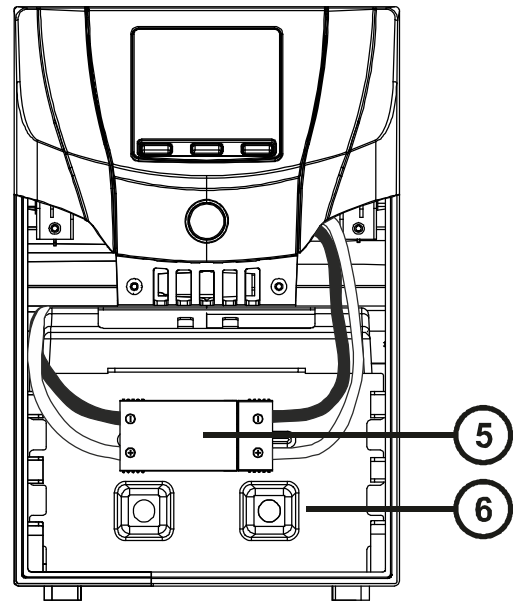
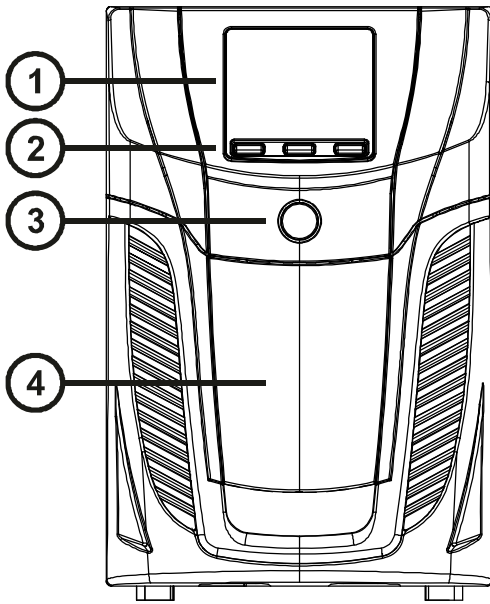

- ① Display
- ② Multipurpose buttons
- ③ ON/OFF Switch

- ④ Removable front panel
- ⑤ Battery pack connector
- ⑥ Battery pack retention panel

REAR VIEW

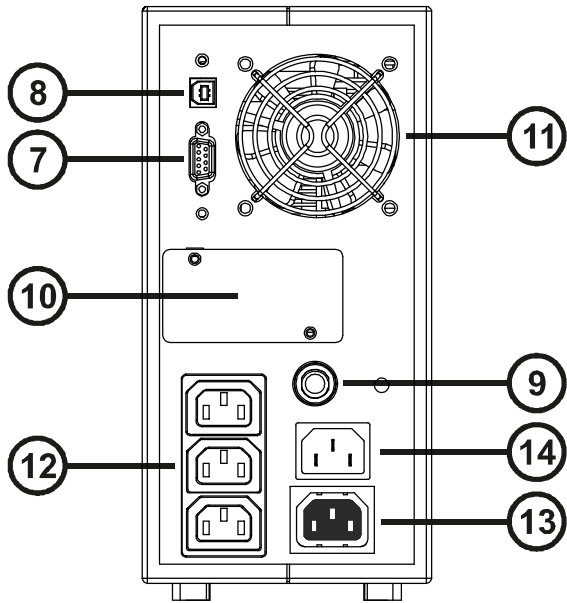

800VA / 1100VA Model

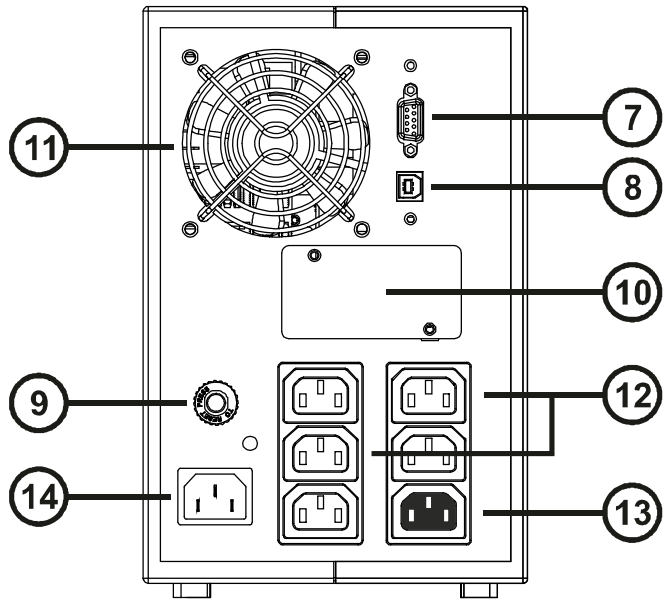

1500VA / 2000VA Model

- 7** Communication port RS232
- 8** USB communication port
- 9** Circuit breaker
- 10** Communication Card Slots

- 11** Cooling fans
- 12** IEC 10A output socket
- 13** Energysshare
- 14** IEC 10A input plug

DISPLAY PANEL VIEW

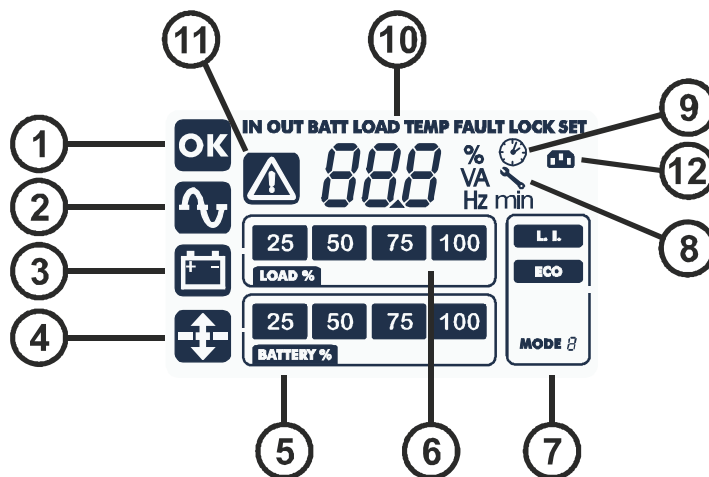

- | | |
|----------------------------|----------------------------|
| Ⓐ "SEL" button (Select) | Ⓔ Load level indicator |
| Ⓑ "ON" button | Ⓕ Configuration area |
| Ⓒ "STAND-BY" button | Ⓖ Maintenance request |
| ① Regular operation | ⑨ Timer |
| ② Mains operation | ⑩ Measurement display area |
| ③ Battery operation | ⑪ Stand-by / alarm |
| ④ AVR active | ⑫ EnergyShare |
| ⑤ Battery charge indicator | |

INSTALLATION

INITIAL CONTENT CHECK

After opening the packaging, it is first necessary to check the contents.
The package must contain:

UPS

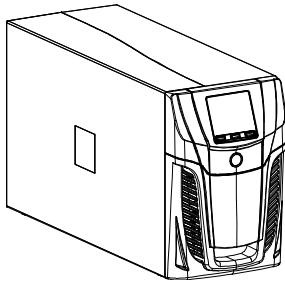

2 IEC 10A connection cables

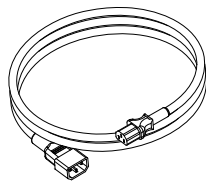

RS232 cable

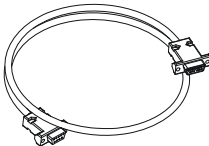

INSTALLATION ENVIRONMENT

The UPS and the Battery Box must be installed in ventilated, clean environments which are sheltered from bad weather. The relative humidity in the environment must not exceed the maximum values shown in the Technical Data table. The ambient temperature, whilst the UPS is in operation, must remain between 0 and 40°C, and the UPS must not be positioned in places which are exposed to direct sunlight or to hot air.



The recommended operating temperature for the UPS and the batteries is between 20 and 25°C. The actual operating life of the batteries is 5 years on average with an operating temperature of 20°C. If the operating temperature reaches 30°C, the operating life is halved.



This is a category C2 UPS product. In a residential environment, this product may cause radio interference, in which case the user may be required to take additional measures.

CONNECTIONS AND SWITCHING ON FOR THE FIRST TIME

- 1) Confirm that the installation upstream of the UPS is adequately protected against overloads and short circuits. It is recommended that the rating of this protection is either 10A or 16A type B or C (depending on the UPS power rating), always check prior to connection.
- 2) Power the UPS using the input cable provided.
- 3) Press the ON/OFF switch located on the front panel.
- 4) After a few moments, the UPS will switch on, the display will light up, there will be a beep and the  icon will start to flash. The UPS is in stand-by mode: meaning that it is only consuming a small amount of power. The microcontroller supervising the self-diagnoses is powered; the batteries are charging; and everything is ready for UPS activation. Battery operation is also in stand-by mode provided that the timer is active.
- 5) Ensure that the cables connecting any devices to the output sockets of the UPS do not exceed a maximum of 10m in length.
- 6) Check which operating mode is set on the display and, if necessary, see the **"Configuring operating modes"** paragraph to set the required mode.

SWITCHING ON FROM THE MAINS

- 1) Press the "ON" button for 1 second. After pressing it, all the icons on the display light up for 1 second and the UPS beeps.
- 2) Switch on the equipment connected to the UPS.

When switching on for the first time only: after 30 seconds, check that the UPS is operating correctly:

- 1) Simulate a blackout by disconnecting power to the UPS.
- 2) The load must continue to be powered, the  icon on the display must light up and there must be a beep every 4 seconds.
- 3) When power is reconnected, the UPS must go back to operating from the mains.

SWITCHING ON FROM THE BATTERY

- 1) Press the ON/OFF switch located on the front panel.
- 2) Hold down the "ON" button for at least 5 seconds. All the icons on the display light up for 1 second.
- 3) Switch on the equipment connected to the UPS.

SWITCHING OFF THE UPS











In order to switch off the UPS, hold down the "STBY" button for at least 2 seconds. The UPS goes back to stand-by mode and the  icon starts to flash:

- 1) If the mains power is present, the ON/OFF switch must be pressed to completely turn off the UPS.
- 2) During battery mode operation with the timer not set, the UPS automatically switches off after 30 seconds. However if, the timer is set, press and hold down the "STBY" key for at least 5 seconds to turn off the UPS. For complete shutdown, press the ON/OFF switch.

DISPLAY PANEL MESSAGES

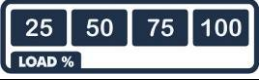
This chapter describes, in detail, the various information that can be displayed on the LCD.

UPS STATUS MESSAGES

ICON	STATUS	DESCRIPTION
	Fixed	Indicates a fault
	Flashing	The UPS is in stand-by mode
	Fixed	Indicates regular operation
	Fixed	The UPS is operating from the mains
	Fixed	The UPS is operating from the battery. In this condition, the UPS emits an acoustic signal (beep) at regular 4-second intervals.
	Flashing	Low battery pre-alarm. Indicates that battery autonomy is coming to an end. In this condition, the UPS emits a beep at regular 1-second intervals.
	Fixed	AVR active
	Dynamic	Indicates the estimated percentage charge of the batteries
	Dynamic	Indicates the percentage of charge applied to the UPS compared with the nominal value.
	Flashing	Maintenance is required. Contact the support centre.
	Fixed	Indicates that the timer is active (programmed switch-on and switch-off). The timer can be activated/deactivated using the software provided.
	Flashing	1 minute until the UPS switches back on or 3 minutes until it switches off
	Off *	The EnergyShare sockets are not configured. (Always active).
	Continuous*	Using UPStools software an event associated with the EnergyShare sockets was configured (e.g. end of discharge pre-alarm threshold) but the sockets are active at this time.
	Flashing *	The associated event occurred; the EnergyShare outlets have been disconnected.

* For more information about the configuration of the EnergyShare sockets, see "Additional Features"











MEASUREMENT DISPLAY AREA

The front panel can be used to display important UPS operating information. When the UPS is switched-on, the display shows the main voltage value.

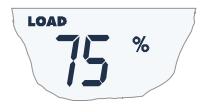
To display a different measurement, press the "SEL" button repeatedly until the desired measurement appears.

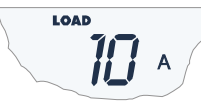
In the event of a fault/alarm (FAULT) or a lock (LOCK), the display will automatically show the type and code of the corresponding alarm.

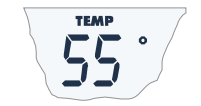
Some examples are shown below:

GRAPHIC EXAMPLE ⁽¹⁾	DESCRIPTION	GRAPHIC EXAMPLE ⁽¹⁾	DESCRIPTION
	Mains voltage		Battery charge percentage
	Mains frequency		Total battery voltage
	UPS output voltage		Applied load percentage
	Output voltage frequency		Current absorbed by the load
	Residual battery autonomy		Temperature of the electronics cooling system inside the UPS
	Fault / Alarm ⁽²⁾ : the corresponding code is displayed		Lock ⁽²⁾ : the corresponding code is displayed

⁽¹⁾ The values shown in the images in the table are purely as an indication.

⁽²⁾ The FAULT / LOCK codes can only be displayed if they are active (presence of a fault/alarm or a lock).

CONFIGURING THE OPERATING MODE

The area of the display shown in the figure displays the active operating mode and allows the user to choose other modes directly from the display panel.



HOW TO PROCEED:

- To access the configuration area, hold down the “SEL” button for at least 3 seconds.
- The icon corresponding to the mode currently set lights up.
- To change the mode, press the “ON” button.
- To confirm the mode chosen, hold down the “SEL” button for at least 3 seconds.

POSSIBLE SETTINGS

The UPS is designed to be configured in various operating modes:

- **L.I.** normal operating mode
- **ECO** is the mode with which the UPS consumes the least amount of power, and is therefore the most efficient
- **MODE** using the *UPS Tools* software it is possible to customise the UPS operational characteristics.

ADDITIONAL FUNCTIONS

MODE “BATTERY SWAP”

The “battery swap” mode ensures that the UPS remains in normal operation from the mains supply. In this condition the load is powered directly by the input mains, any disruption in the mains directly affects the load.



ATTENTION:
PRIOR TO PERFORMING THE FOLLOWING PROCEDURE ENSURE THAT THE UPS IS NOT IN BATTERY OPERATION MODE

Attention: even when the UPS is switched on, the load is disconnected in the event of a mains blackout.

If the input mains deviates from the established tolerances, the UPS automatically switches to Stdby mode and disconnects the load.

To force the UPS into “battery swap” mode press and hold the ON and SEL keys at the same time for at least 4 sec.

The code "C02" appears on the display.

To return to the normal operation mode press the ON and SEL keys again for at least 4 sec.

PROGRAMMABLE AUXILIARY SOCKET (EnergyShare)

The EnergyShare sockets are outlets that allow for the automatic disconnection of the load applied to them in certain operating conditions. The events that determine automatic disconnection of the EnergyShare sockets can be selected by the user through the **UPStools** configuration software. For example, it is possible to select disconnection after a certain period of battery operation; or when the pre-alarm threshold for battery discharge has been reached, or when an overloading event occurs.

By default the Energysshare sockets are not configured and therefore function as other outlets.

The EnergyShare function is associated with an icon on the display whose meaning is explained in the paragraph entitled “**Display panel indications**”

The presence and the number of these sockets depend on the UPS type, and they are distinguished by a different colour with respect to other sockets.

BATTERY PACK REPLACEMENT

The UPS is also equipped with a dedicated battery pack that allows for easy replacement of batteries (**hot swap**) in complete safety, thanks to the protected connection system.



- **WHEN THE BATTERY PACK IS DISCONNECTED, THE LOADS CONNECTED TO THE UPS ARE NOT PROTECTED IN THE EVENT OF A MAINS FAILURE**
- **THE BATTERY PACK IS VERY HEAVY. USE EXTREME CAUTION WHEN REPLACING IT.**

1. Set the UPS in “battery swap” mode by pressing and holding both the ON and SEL button for 4 seconds (See par. USE / Operating mode configuration) on the display will appear the code “C02” NOTE: in this condition the load is powered from the mains supply.

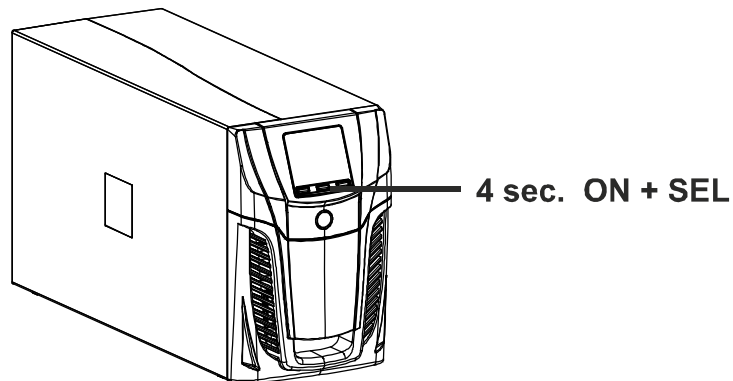

2. The battery pack is positioned behind the UPS front panel. Remove the front panel as shown in the figure below. Disconnect the connector that connects the battery pack to the UPS.

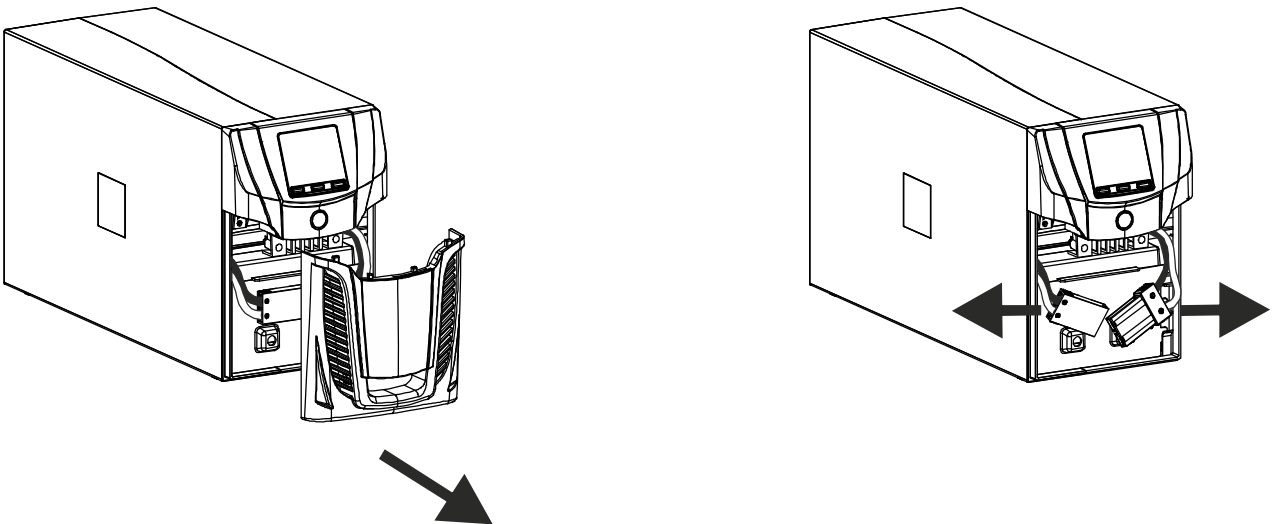

3. Remove the battery pack's retention panel carrying out the operations shown in the figure below.

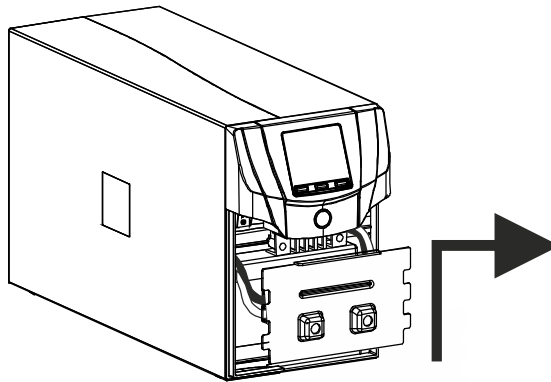

4. Slip off the battery pack pulling it towards the outside, as shown in the figure below. Be careful when extracting and lifting up the battery pack as it is heavy.. ATTENTION: the new battery pack must contain the same number and type of batteries (see the label located on the battery pack near the connector).

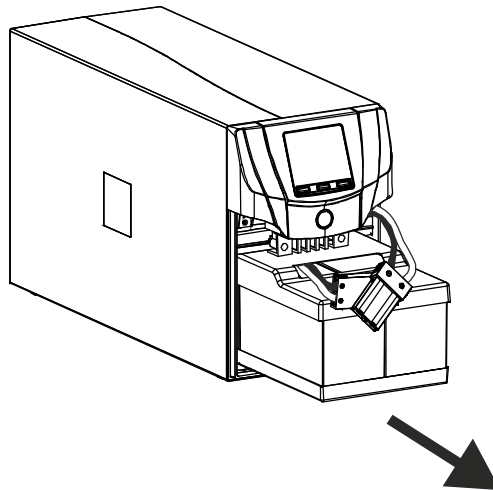

5. Insert the new battery pack into the compartment, sliding it into the UPS Replace the battery pack retaining plate. Connect the battery pack cable to the UPS and close the front panel. Set the UPS to normal operation mode by pressing ON + SEL for at least 4 seconds.
6. Make sure that the display does not show the code C02.
7. Press the ON key for 5 seconds to start the battery status verification procedure.

TROUBLESHOOTING

Irregular UPS operation is not always an indication of a fault, and can be due to minor or easy-to-resolve issues. It is therefore advisable to consult the table below as it contains information which is useful for solving the most common UPS problems.

PROBLEM	POSSIBLE CAUSE	SOLUTION
THE DISPLAY DOES NOT LIGHT UP	ON/OFF SWITCH NOT PRESSED	Press the ON/OFF switch on the front panel.
	MAIN CONNECTION CABLE MISSING	Check that the power cable is connected correctly.
	NO MAINS VOLTAGE (BLACKOUT)	Check that the power reaches the socket where the UPS is connected (try it with a table lamp, for example).
	INTERVENTION OF THE INPUT CIRCUIT BREAKER	If present, reset the circuit breaker by pressing the button on the back of the UPS. CAUTION: Check that there is no output overload to the UPS.
THE DISPLAY IS ON BUT THE LOAD IS NOT POWERED	THE UPS IS IN STAND-BY MODE	Press the "ON" button on the front panel to power the loads.
	NO CONNECTION TO THE LOAD	Check the connection to the load.
THE UPS IS OPERATING FROM THE BATTERY DESPITE THE PRESENCE OF MAINS VOLTAGE	THE INPUT VOLTAGE IS OUTSIDE THE PERMITTED TOLERANCE RANGE FOR MAINS OPERATION	Problem with the mains. Wait until the input mains voltage returns within the tolerance range. The UPS will automatically return to mains operation.
	INTERVENTION OF THE INPUT CIRCUIT BREAKER	If present, reset the circuit breaker by pressing the button on the back of the UPS. CAUTION: Check that there is no output overload to the UPS.
THE UPS DOES NOT COME ON AND THE DISPLAY SHOWS THE CODE: A06, A08	THE TEMPERATURE OF THE UPS IS LOWER THAN 0°C	Check the temperature of the environment in which the UPS is located; if it is too low, bring it past the minimum threshold (0°C).
THE DISPLAY SHOWS THE FOLLOW CODES: L11	INPUT RELAY FAULTY	Switch off and disconnect the UPS from the power supply and contact the support centre.

PROBLEM	POSSIBLE CAUSE	SOLUTION
THE BUZZER SOUNDS CONTINUOUSLY AND THE DISPLAY SHOWS ONE OF THE FOLLOWING CODES: A54, F50, F51, F52, L50, L51, L52	THE LOAD APPLIED TO THE UPS IS TOO HIGH	Reduce the load to within the threshold of 100% (or user threshold in the case of code A54). If the display shows a lock, remove the load and switch the UPS off and back on again.
THE DISPLAY SHOWS THE FOLLOW CODE: A61	REPLACE THE BATTERIES	Contact the support centre for battery replacement.
THE DISPLAY SHOWS THE FOLLOW CODE: A62	BATTERY MISSING OR NOT CONNECTED	Check that the battery pack is present and connected
THE DISPLAY SHOWS THE FOLLOW CODE: A63	THE BATTERIES ARE FLAT; THE UPS IS WAITING FOR THE BATTERY VOLTAGE TO EXCEED THE SET THRESHOLD	Wait until the batteries have recharged or force power-on manually by holding down the "ON" button for at least 2 seconds.
THE BUZZER SOUNDS CONTINUOUSLY AND THE DISPLAY SHOWS THE FOLLOW CODE: F38	THE UPS IS MALFUNCTIONING; IT WILL PROBABLY LOCK SOON	If possible, disconnect the power to the load, switch the UPS off and back on again; if the problem occurs again, call the support centre.
THE BUZZER SOUNDS CONTINUOUSLY AND THE DISPLAY SHOWS ONE OF THE FOLLOWING CODES: F04, L04	THE TEMPERATURE OF THE HEATSINKS INSIDE THE UPS IS TOO HIGH	Check that the temperature of the environment in which the UPS is located does not exceed 40°C.
THE BUZZER SOUNDS CONTINUOUSLY AND THE DISPLAY SHOWS ONE OF THE FOLLOWING CODES: F53, L53	THERE IS A FAULT ON ONE OR MORE OF THE UTILITIES POWERED BY THE UPS	Disconnect all the utilities, switch the UPS off and back on again, reconnect the utilities one at a time to identify which one is faulty.
THE BUZZER SOUNDS CONTINUOUSLY AND THE DISPLAY SHOWS ONE OF THE FOLLOWING CODES: F60, L05, L07, L13, L20, L21, L40, L41, L42, L43	THE UPS IS MALFUNCTIONING	If possible, disconnect the power to the load, switch the UPS off and back on again; if the problem occurs again, call the support centre.
THE DISPLAY SHOWS ONE OF THE FOLLOWING CODES: C01, C02, C03	A REMOTE COMMAND IS ACTIVE	If unwanted, check the status of the command inputs on any optional contact card.
THE DISPLAY SHOWS C02	THE "BATTERY SWAP" MODE IS ACTIVATED"	To exit from the "battery swap" mode, press and hold the ON/SEL buttons for at least 4 seconds



ATTENTION:

The UPS in case of a permanent failure will be not able to supply the load. To ensure total protection of your equipment we suggest you install an ATS device (Automatic Transfer Switch) or an external automatic by-pass.

ALARM CODES

Using a sophisticated self-diagnosis system, the UPS is able to check its own status for any anomalies and/or faults which may occur during normal operation and display them on the display panel. If there is a problem, the UPS signals the event by showing the code and the type of active alarm on the display (FAULT and/or LOCK).

FAULT

FAULT alerts can be divided into three categories:

- **Anomalies:** these are “minor” problems which do not cause the lock of the UPS but reduce performance or prevent certain functions from being used.

CODE	DESCRIPTION
A06	Sensor1 temperature under 0°C
A08	Sensor2 temperature under 0°C
A54	Load percentage greater than the user threshold set
A61	Replace batteries
A62	Batteries missing or Battery Box missing or not connected
A63	Waiting for battery charging

- **Alarms:** these are more critical problems than anomalies because, if they persist, they could cause the UPS to lock in a very short time.

CODE	DESCRIPTION
F04	Heatsink over temperature
F05	Temperature sensor1 faulty
F07	Temperature sensor2 faulty
F38	Battery charger faulty
F50	Overload: load > 103%
F51	Overload: load > 110%
F52	Overload: load > 150%
F53	Short circuit
F60	Battery overvoltage

- **Active commands:** Indicates the presence of an active remote command.

CODE	DESCRIPTION
C01	Remote control 1 (Switch On/Off)
C02	Remote control 2 (Load supplied by the mains)
C03	Remote control 3 (Switch On/Off)
C04	Battery test in progress

LOCK

LOCK alerts are normally preceded by an alarm signal and their scale leads to the powering-off of the inverter with the load being powered by the bypass line (this procedure is excluded for locks due to serious, persistent overloads and short circuits).

CODE	DESCRIPTION
L04	Heatsink over temperature
L05	Temperature sensor1 faulty
L07	Temperature sensor2 faulty
L11	Input relay faulty
L13	Capacitor pre-charge failed
L20	Capacitor bank undervoltage
L21	Capacitor bank overvoltage
L40	Inverter overvoltage
L41	Continuous output voltage
L42	Incorrect inverter voltage
L43	Inverter undervoltage
L50	Overload: load > 103%
L51	Overload: load > 110%
L52	Overload: load > 150%
L53	Short circuit

TECHNICAL DATA

UPS MODELS	VST 800	VST 1100	VST 1500	VST 2000
------------	---------	----------	----------	----------

INPUT

Nominal voltage	[Vac]	220 - 230 - 240			
Maximum operating voltage	[Vac]	300			
Nominal frequency	[Hz]	50 - 60			
Rated current (1)	[A]	3.9	5.3	7.4	9.7

BATTERY

Recharge time (standard versions)	[h]	< 4h for 80% of the load			
No. of internal batteries		2	2	4	4

OUTPUT

Nominal voltage (2)	[Vac]	Selectable: 220 / 230 / 240			
Frequency	[Hz]	Selectable: 50, 60 or self-learning			
Nominal power	[VA]	800	1100	1500	2000
Nominal power	[W]	640	880	1200	1600
Overloading: 100% < load < 110%	From mains:	locked after 5 min			
	From battery:	locked after 60 sec			
Overloading: 110% < load < 150%	From mains:	locked after 10 sec			
	From battery:	locked after 5 sec			
Load overload > 150%	From mains:	locked after 1 sec			
	From battery:	locked 0.5 sec			

OTHER DATA

Leakage current towards ground	[mA]	1			
Room temperature (3)	[°C]	0 – 40			
Humidity		< 90% without condensation			
Protection devices		excessive battery discharge - over current - short circuit - over voltage - under voltage - thermal			
Dimensions W x D x H	[mm]	120 x 443 x 247		160 x 443 x 247	
Weight	[Kg]	10.5	11.3	17.5	18.5

⁽¹⁾ @ rated load, rated voltage of 220 Vac, battery charging

⁽²⁾ To maintain output voltage within the accuracy range specified, recalibration may be necessary after a long period of operation

⁽³⁾ 20 - 25 °C for longer battery life